

SILICONE OPTICS FOR COB MODULES

M-CLASS / AREA / SYM II



SILICONE OPTICS FOR COB MODULES

M-Class / Area / SYM II

M-Class silicone optics especially designed and optimized for the use of COB modules with LES sizes up to 23 mm.

COB Silicone Optics

- **EXCELLENT LUMINOUS TRANSMITTANCE**
- **OPTICAL EFFICIENCY: UP TO 97 %**
- **OPTIMIZED FOR THE USE WITH LUGA COB MODULES**
- **SELF SEALING ABILITY (IP65)**
- **HIGH THERMAL STABILITY**
- **IK STABILITY OF SILICONE OPTICS: IK08**
- **UV RESISTANT**

COB Silicone Optics for Street Lighting – M-Class

Technical Notes

- Dimensions (incl. frame) ØxH: 100x24 mm
- Optics for street lighting M-Class applications (acc. to EN 13201), asymmetric light beam
- Optimum illumination installation ratio of 4:1 (pole distance to pole height)



Optical Characteristics

LED module	Beam angle	Optical efficiency
LUGA (LES 22)	Asymmetric	93%

Typical Light Distribution Curve

Measured COB module: DMx11xxx

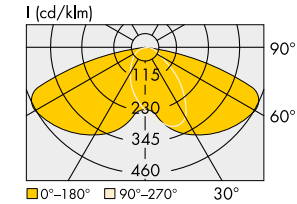

Using COBs from other manufacturers will influence the resulting appearance of the above shown light distribution.

Maximum Ratings and Reference Numbers

Exceeding the maximum ratings can lead to reduction of service life or destruction of the optics and the holders.

Type	Ref. No.	Material	Operation temperature range		Storage temperature range	
			°C min.	°C max.	°C min.	°C max.
Silicone optics (M-Class)	559042	Silicone, transparent	-40	+120	-40	+85
Holder	558607	PC, black	-40	+85	-40	+85

Dimensions

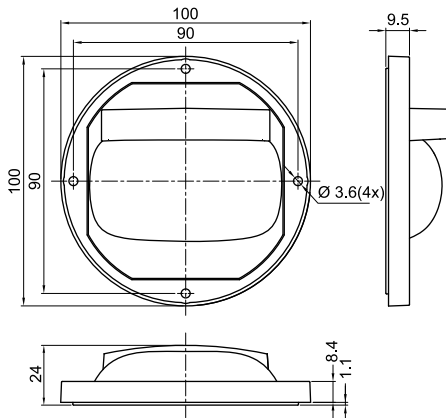

Hole Pattern

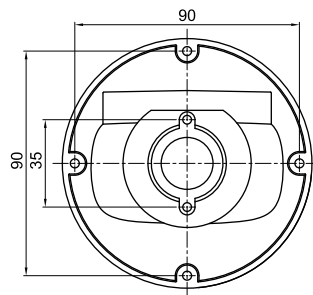

Holder

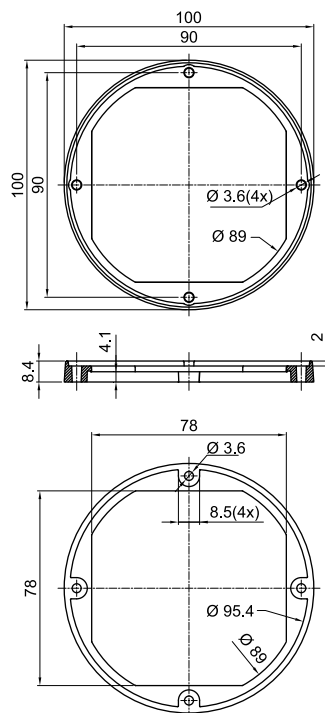

The values contained in this data sheet can change due to technical innovations. Any such changes will be made without separate notification.

COB Silicone Optics for Outdoor Lighting – Area

Technical Notes

- Dimensions (incl. frame) ØxH: 100x23 mm
- Optics for public places
- Optimum illumination installation ratio of 4.5:1 (pole distance to pole height)



Optical Characteristics

LED module	Beam angle	Optical efficiency
LUGA (LES 22)	Symmetric	96%

Typical Light Distribution Curve

Measured COB module: DMx11xxx

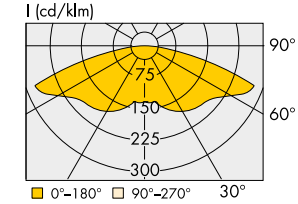

Using COBs from other manufacturers will influence the resulting appearance of the above shown light distribution.

Maximum Ratings and Reference Numbers

Exceeding the maximum ratings can lead to reduction of service life or destruction of the optics and the holders.

Type	Ref. No.	Material	Operation temperature range		Storage temperature range	
			°C min.	°C max.	°C min.	°C max.
Silicone optics (Area)	562512	Silicone, transparent	-40	+120	-40	+85
Holder	558607	PC, black	-40	+85	-40	+85

Dimensions

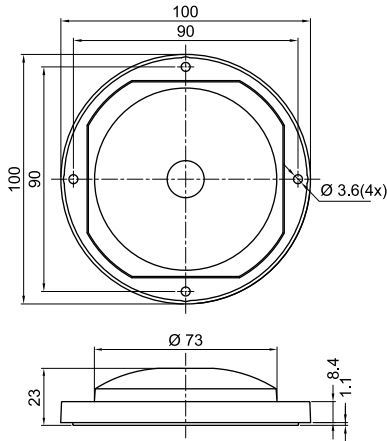

Hole Pattern

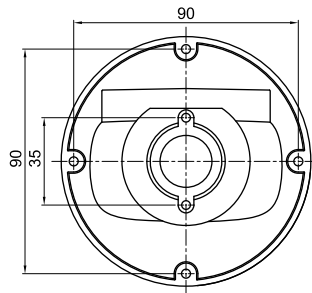

Holder

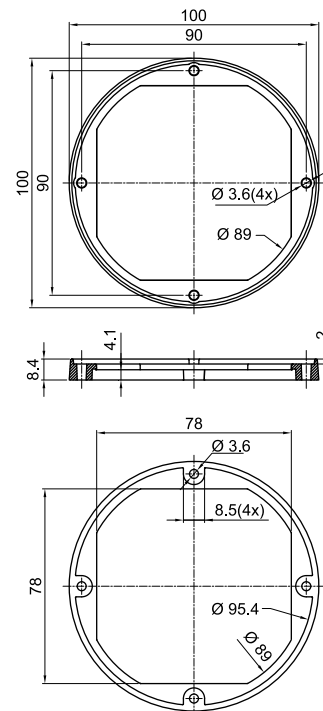

The values contained in this data sheet can change due to technical innovations. Any such changes will be made without separate notification.

COB Silicone Optics for Industrial Lighting – SYM II

Technical Notes

- Dimensions (incl. frame) ØxH: 100x24.6 mm
- Optics for industrial and hall lighting
- Optimum illumination installation ratio of 2:1 (luminaire distance to luminaire height)



Optical Characteristics

LED module	Beam angle	Optical efficiency
LUGA (LES 22)	Symmetric	97%

Typical Light Distribution Curve

Measured COB module: DMx11xxx
I (cd/klm)

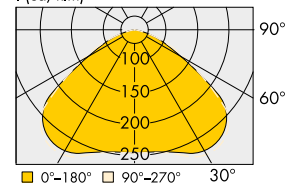

Using COBs from other manufacturers will influence the resulting appearance of the above shown light distribution.

Maximum Ratings and Reference Numbers

Exceeding the maximum ratings can lead to reduction of service life or destruction of the optics and the holders.

Type	Ref. No.	Material	Operation temperature range		Storage temperature range	
			°C min.	°C max.	°C min.	°C max.
Silicone optics (SYM II)	562513	Silicone, transparent	-40	+120	-40	+85
Holder	558607	PC, black	-40	+85	-40	+85

Dimensions

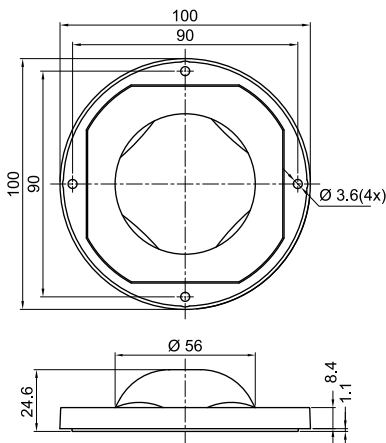

Hole Pattern

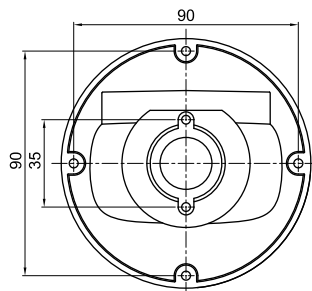

Holder

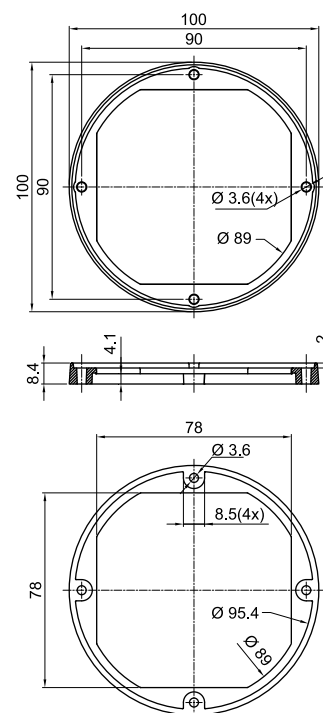

The values contained in this data sheet can change due to technical innovations. Any such changes will be made without separate notification.

COB Silicone Optics – M-Class / Area / SYM II

LUGA C/Shop holder

For DMS120***F, DMS150***F, DMC11C***E,
DMC16C***E, DMC12C***F, DMC18C***F,
DMS120***G, DMS12C***G, DMS18C***G

Material: PBT, white

Dimensions (ØxH): 50x4.2 mm

Fixing holes for screws M3

Hole distance: 35 mm

U_{max.}: 190 V DC for basic insulation

I_{max.}: 3 A

Type: 89720, Unit: 250 pcs.

Ref. No.: 559164 Ø 50 mm

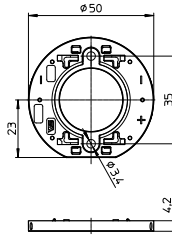

Assembly and Safety Information

- Installation must be carried out under observation of the relevant regulations and standards.
- Suggested min. distance between single lenses (to prevent influences on the light distribution)
x: 10 mm (along the road)
y: 1 mm (perpendicular to the road)
- The optics incl. holder frame must be fixed onto a smooth and flat surface with four M3 screws (must have, to achieve IP65).
Recommended torque: 0.6 Nm
- To ensure IK-rating of luminaire, the holder ring (Ref. No. 558607) must be covered/protected by e.g. metal parts of the luminaire.
The holder ring is not IK08 rated.
- Due to use of high power COB modules in connection with the silicone lens, special attention to proper thermal design is highly recommended. VS has no liability for direct, indirect or consecutive damages arising from the optics or holder ring being used outside the stated temperature range (see table: Maximum Ratings).
- The typical light distribution will be changed by the use of different LES (Light Emitting Surface) size and chip position tolerance.
- Handle with care. Do not install the optics or touch optical parts without wearing gloves. Non observance may lead to damages of the optics or to affect the light transmission.
- Cleaning of optics should be done with mild soap and water by using a soft cloth. Do not use any commercial cleaning solvents.

List of Incompatible Chemicals

Subsequent listed materials must not be used in connection with the products (totality cannot be guaranteed)

Chemical Description	Often included in ...
Ketone, ester	polar solvents
Amine, urethane or amin-containing materials	
Phosphor and phosphor-containing materials	softener, flame retardant
Halogens (Br, I, F-containing compounds)	flame retardants
Nicotine	cigarette smoke
Chromophores (phthalate or phthalate acid ester, paraben)	softener, cosmetics
Benzene, toluol, xylol	non-polar, aromatic solvents
Chlorinated hydrocarbon (dichloromethane, chloroform, carbon tetrachloride etc.)	chlorinated solvents
Ether (e.g. tetrahydrofuran)	solvents
Hot grease and oil > 150 °C (e.g. vaseline, silicone and mineral oil)	lubricants
Concentrated bases and acids (e.g. acid sulphur, nitric acid, phosphoric acid), alcoholic bases (sodium hydroxide, potassium hydroxide)	
Hydrocarbons (e.g. benzine, hexane, cyclohexane, petroleum ether)	non-polar solvents

These silicone optics allow the diffusion of gases, therefore gaseous chemicals can penetrate the lens and harm the LED module.
Detailed information can be found in our "Chemical Incompatibility" PDF on our website www.vossloh-schwabe.com

The values contained in this data sheet can change due to technical innovations. Any such changes will be made without separate notification.