

CC COMPACT SIMPLE FIX



COMFORTLINE SIMPLE FIX C-R3

**186719, 186720, 186721, 186722, 186723,
186724, 186725, 186726, 186727, 186728**

Typical Applications

Built-in in compact luminaires

- Shop lighting
- Downlights



ComfortLine Simple Fix C-R3

- **VERY LOW RIPPLE CURRENT: < 3%**
- **SUITABLE FOR EMERGENCY ESCAPE LIGHTING SYSTEMS ACC. TO EN 50172**
- **WITH INTEGRATED CORD GRIP FOR INDEPENDENT OPERATION**
- **SELV**
- **LONG SERVICE LIFE:
UP TO 100,000 HRS.**
- **PRODUCT GUARANTEE: 5 YEARS**



ComfortLine Simple Fix C-R3

Product features

- Compact casing shape
- For independent operation with integrated cord grip
- For built-in without cord grip
- Active power factor corrector

Functions

- Suitable for central battery system for emergency lighting acc. to EN 50172

Electrical features

- Mains voltage: 220–240 V $\pm 10\%$
- Mains frequency: 50–60 Hz
- DC operation: 176–264 V, 0 Hz
- Push-in terminals for built-in: 0.5–1.5 mm², for independent: 0.75–1.5 mm²
- Power factor at full load: 0.95
- Open circuit voltage (U_{max.}): 60 V
- Secondary side switching of LED modules is not allowed.

Safety features

- Protection against transient main peaks
- Electronic short-circuit protection
- Overload protection
- Overtemperature protection
- Protection against "no load" operation
- Degree of protection: IP20
- Protection class I for built-in, protection class II for independent
- SELV

Packaging units

Ref. No.	Packaging unit		
	Pieces per box	Boxes per pallet	Weight g

Built-in drivers

186720	50	75	96
186722	50	75	96
186724	50	75	96
186726	50	75	102
186728	50	75	103

Independent drivers

186719	40	75	134
186721	40	75	134
186723	40	75	134
186725	40	75	141
186727	40	75	142

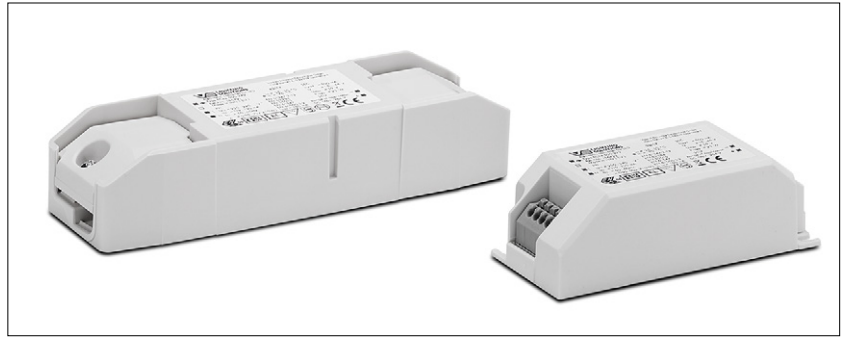

Dimensions built-in drivers

- Casing: K33.2
- Length: 97.1 mm
- Width: 42.6 mm
- Height: 30.3 mm

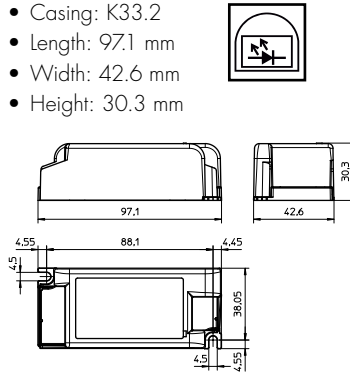

Dimensions independent drivers

- Casing: K33.2
- Length: 146.5 mm
- Width: 43.5 mm
- Height: 30 mm

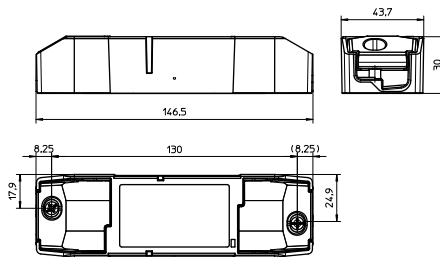

Applied standards

- EN 61347-1
- EN 61347-2-13
- EN 61547
- EN 61000-3-2
- EN 61000-3-3
- EN 62384
- EN 55015
- VDE 0710-T14



Product guarantee

- 5 years
- The conditions for the Product Guarantee of the Vossloh-Schwabe Group shall apply as published on our homepage (www.vossloh-schwabe.com). We will be happy to send you these conditions upon request.

The values contained in this data sheet can change due to technical innovations. Any such changes will be made without separate notification.

LED Drivers – ComfortLine Simple Fix C-R3

Electrical characteristics

Max. output W	Type	Ref. No. independent	Ref. No. built-in	Voltage 50–60 Hz V	Mains current mA	Inrush current A / μ s	Current output DC mA (\pm 5%)	Voltage output DC (V)	THD %	Efficiency at full load % (230 V)	Ripple 100 Hz %
16	ECXe 350.278	186719	186720	220–240	100–91	5 / 50	350	15–46	7.1	> 89	< 3
23	ECXe 500.279	186721	186722	220–240	130–119	5 / 50	500	15–46	6.6	> 90	< 3
32	ECXe 700.280	186723	186724	220–240	170–150	5 / 50	700	15–45	7.2	> 91	< 3
38	ECXe 900.281	186725	186726	220–240	200–183	5 / 50	900	15–42	8.6	> 91	< 3
42	ECXe 1050.282	186727	186728	220–240	230–210	5 / 50	1050	15–40	9.4	> 90	< 3

Maximum ratings

Exceeding the maximum ratings can lead to reduction of service life or destruction of the drivers.

Ref. No.	Ambient temperature range		Operation humidity range		Storage temperature range		Storage humidity range		Max. operation temperature at t_c point °C	Degree of protection
	°C min.	°C max.	% min.	% max.	°C min.	°C max.	% min.	% max.		
186719, 186720, 186722	-25	+50	5	80	-30	+80	5	85	+70	IP20
186721, 186724	-25	+50							+75	
186723, 186726	-25	+45							+75	
186725	-25	+40							+75	
186727	-25	+40							+80	
186728	-25	+45							+80	

Expected service life time

at operation temperatures at t_c point

Operation current	Ref. No.	186719, 186720, 186722	186721, 186724, 186723, 186726, 186725	186727, 186728
All	60 °C	70 °C	65 °C	75 °C
hrs.	100,000	50,000	100,000	50,000

Product labels

The product labels are arranged in a 3x4 grid. Each label contains the following information:

- VS LIGHTING SOLUTIONS** logo and company name: Vossloh-Schwabe Deutschland GmbH, Hohe Steinert 8, D-58509 Lüdenscheid.
- Electronic converter for LED** and **SEC** (Safety Extra Class) marking.
- Type** and **Rated current** (e.g., Type ECXe 350.278, I_{rated} = 350 mA).
- Input Voltage (UN)** and **Input Current (IN)** specifications.
- Output Voltage (U)** and **Output Current (I_{OUT})** specifications.
- Power (P)** and **Efficiency** information.
- Range of application** and **DC output voltage** (e.g., DC 176V..264 V).
- Input inrush current (I_{inrush})** and **Power factor (PF)**.
- CE**, **SELV**, and other safety certification logos.

The values contained in this data sheet can change due to technical innovations. Any such changes will be made without separate notification.

LED Drivers – ComfortLine Simple Fix C-R3

Typ. performance graphs for 186719 and 186720 / Type ECXe 350.278

Working area

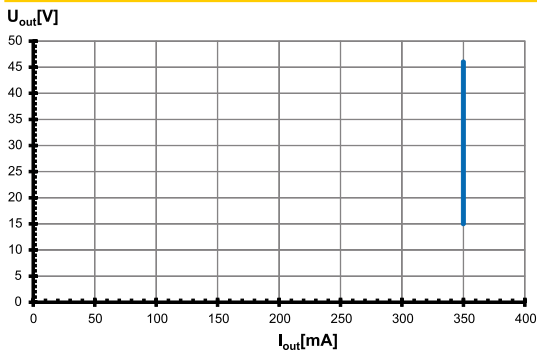

Efficiency

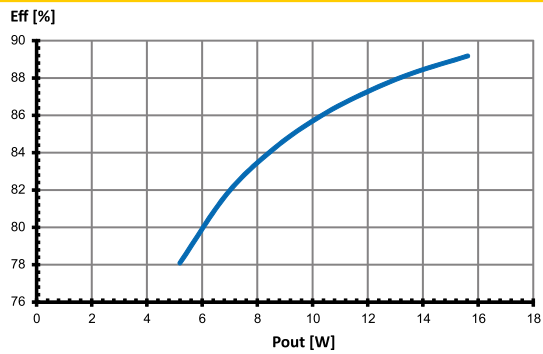

Power factor

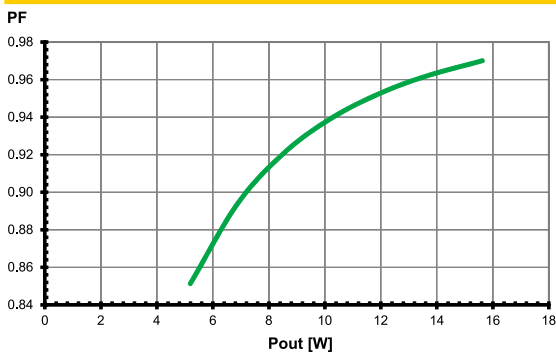

Total harmonic factor (THD)

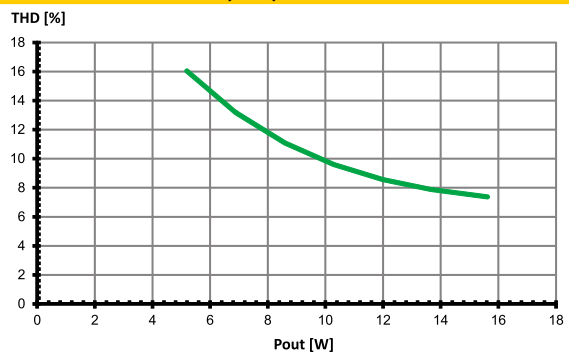

Typ. performance graphs for 186721 and 186722 / Type ECXe 500.279

Working area

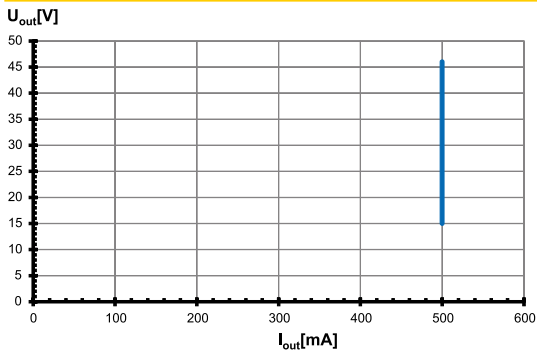

Efficiency

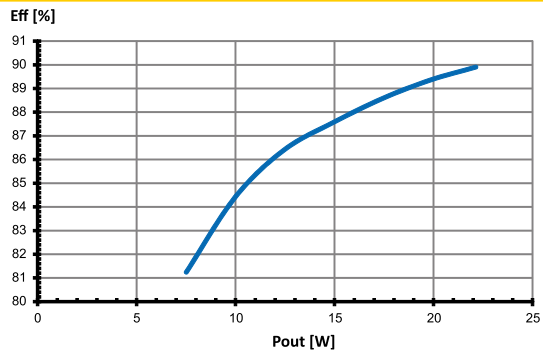

Power factor

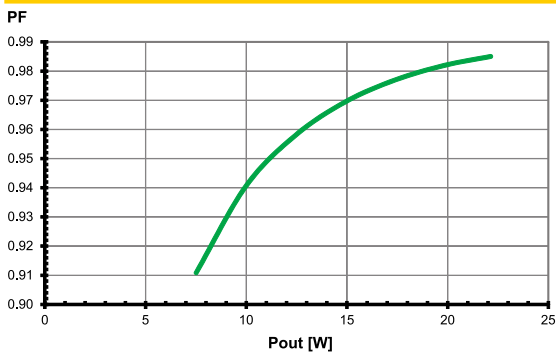

Total harmonic factor (THD)

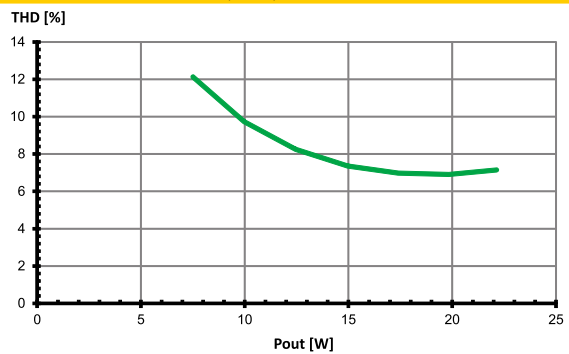

The values contained in this data sheet can change due to technical innovations. Any such changes will be made without separate notification.

LED Drivers – ComfortLine Simple Fix C-R3

Typ. performance graphs for 186723 and 186724 / Type ECXe 700.280

Working area

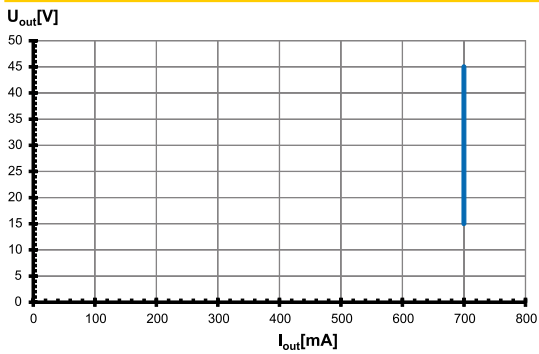

Efficiency

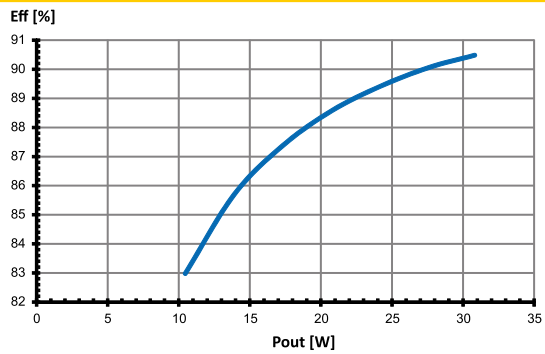

Power factor

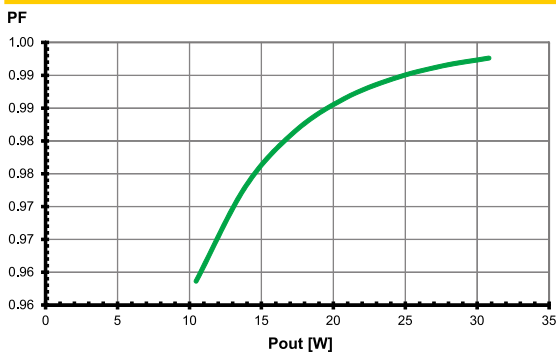

Total harmonic factor (THD)

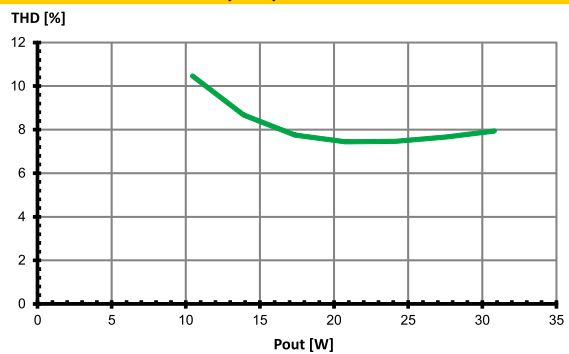

Typ. performance graphs for 186725 and 186726 / Type ECXe 900.281

Working area

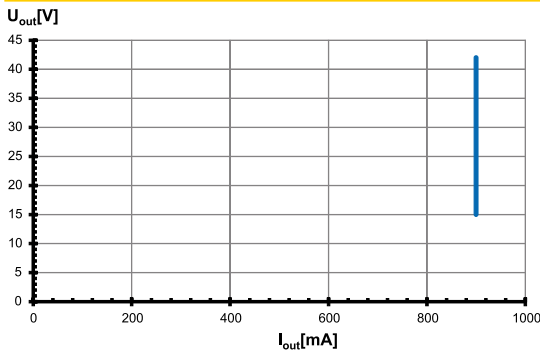

Efficiency

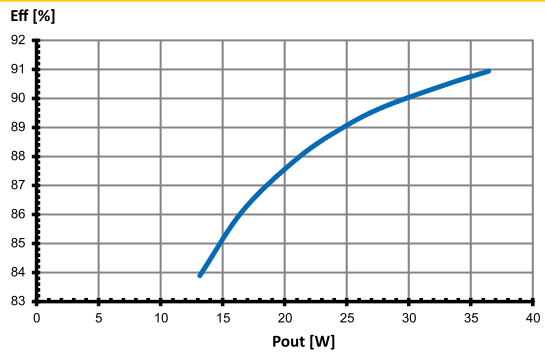

Power factor

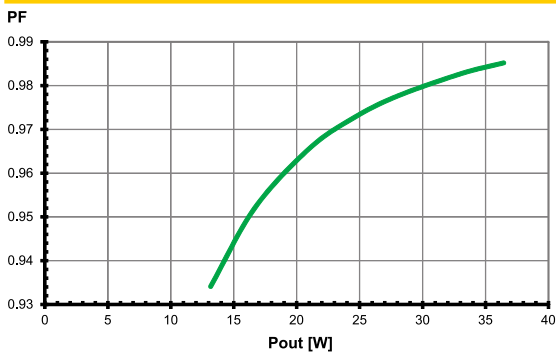

Total harmonic factor (THD)

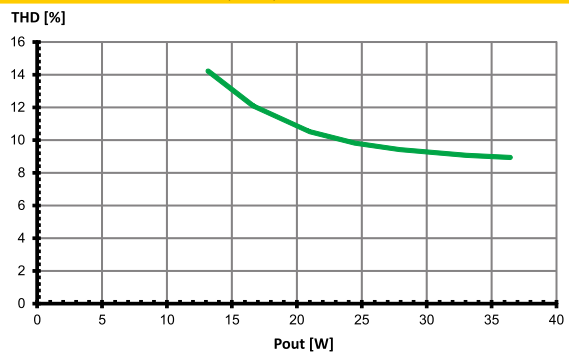

The values contained in this data sheet can change due to technical innovations. Any such changes will be made without separate notification.

Typ. performance graphs for 186727 and 186728 / Type ECXe 1050.282

Working area

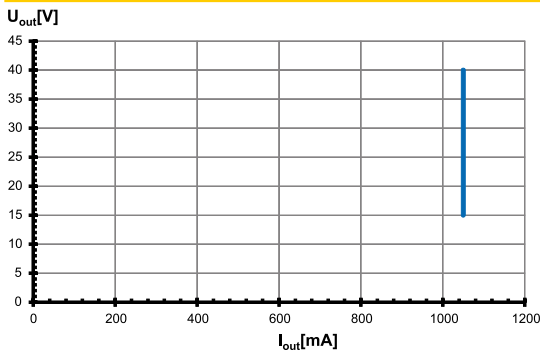

Efficiency

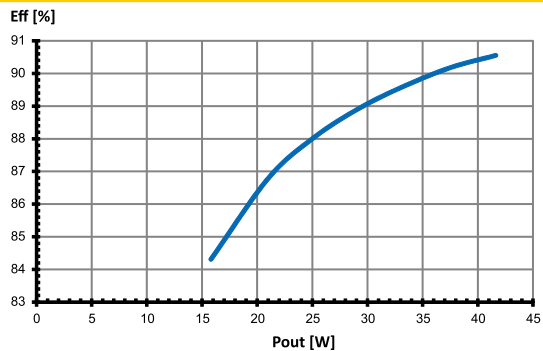

Power factor

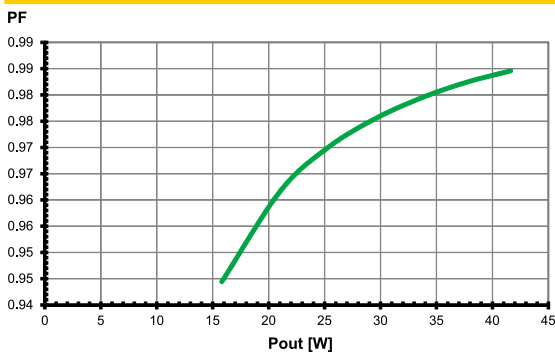

Total harmonic factor (THD)

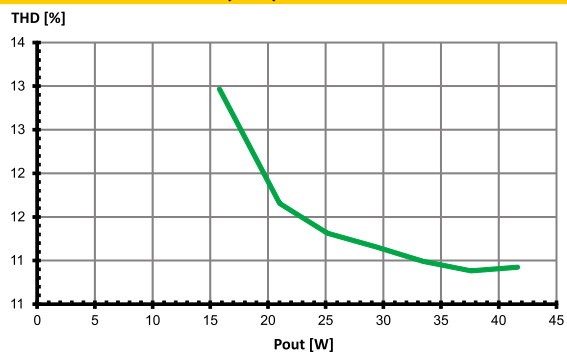

Safety functions

- Transient mains peaks protection:
 - Values are in compliance with EN 61547 (interference immunity).
 - Surges between L/N-PE: up to 2 kV
- Short-circuit protection:
 - The control gear is protected against permanent short-circuit with automatic restart function.
- Overload protection: The control gears have overload protection due to limitation of DC output voltage < 60 V. Please check before switch-on mains power supply that the selected LED load is suitable (see Electrical Characteristics on data sheet).
- Overheating:
 - The control gears have overheating protection. In case of overheating the control gear will shut down. For restart switch of the mains for 1 min. and start again.
 - The temperature reduces the output current of the control gear in the event of overheating.
- No load operation: The control gear is protected against no load operation (open load).
- If any of the above mentioned safety functions will be triggered, disconnect the control gear from the power supply then find and eliminate the cause of the problem.

DC and emergency lighting operation

The control gears are suitable for direct voltage operation (DC). Reliable DC operation is guaranteed if the specified working area of LED driver is maintained.

- Light level at DC operation (EOfx):
 - 100 % (not adjustable)
- DC range: 198–276 V
- Reducing to 176 V: With reduced service life time possible
- DC operation: 3 hrs. (acc. to EN 50172)

The values contained in this data sheet can change due to technical innovations. Any such changes will be made without separate notification.

Assembly and Safety Information

Installation must be carried out under observation of the relevant regulations and standards. Installation must be carried out in a voltage-free state (i.e. disconnection from the mains). The following advices must be observed; non-observance can result in the destruction of the LED drivers, fire and/or other hazards.

Mandatory regulations

- DIN VDE 0100
- EN 60598-1

Mechanical mounting

- Mounting position: Built-in: Any position inside a luminaire is allowed
Independent application: Drivers with integrated cord grip are allowed to use for independent applications.
- Mounting location: LED drivers are designed for integration into luminaires or comparable devices. Independent LED drivers do not need to be integrated into a casing. Installation in outdoor luminaires: degree of protection for luminaire with water protection rate ≥ 4 (e.g. IP54 required).
- Degree of protection: IP20
- Clearance: Min. 0.10 m from walls, ceilings and insulation
- Surface: Solid and plane surface for optimum heat dissipation required.
- Heat transfer: If the driver is destined for installation in a luminaire, sufficient heat transfer must be ensured between the driver and the luminaire casing. LED drivers should be mounted with the greatest possible clearance to heat sources. During operation, the temperature measure at the driver's t_c point must not exceed the specified maximum value.
- Fastening: Using M4 screws in the designated holes
- Tightening torque: 0.2 Nm

Electrical installation

- Connection terminals: Push-in terminals for rigid or flexible conductors with a section of 0.5–1.5 mm² for built-in; 0.75–1.5 mm² for independent
- Stripped length: 9–10 mm
- Wiring: The mains conductor within the luminaire must be kept short (to reduce the induction of interference). Mains and lamp conductors must be kept separate and if possible should not be laid in parallel to one another. Max. secondary side lead length for independent drivers: 1 m

- Polarity: Please ensure the correct polarity of the leads prior to commissioning. Reversed polarity can destroy the modules.
- Parallel connection: At secondary side is not allowed.
- Through-wiring: Is not allowed
- Secondary load: The sum of forward voltages of LED loads is within the tolerances which are mentioned in the Electrical Characteristics on the data sheet.
- Wiring diagram:

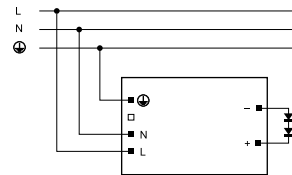

Selection of automatic cut-outs for VS LED drivers

- Dimensioning automatic cut-outs
High transient currents occur when an LED driver is switched on because the capacitors have to load. Ignition of LED modules occurs almost simultaneously. This also causes a simultaneous high demand for power. These high currents when the system is switched on put a strain on the automatic conductor cut-outs, which must be selected and dimensioned to suit.
- Release reaction
The release reaction of the automatic conductor cut-outs comply with VDE 0641, part 11, for B, C characteristics. The values shown in the following tables are for guidance purposes only and are subject to system-dependent change.
- No. of LED drivers
The maximum number of VS LED drivers applies to cases where the devices are switched on simultaneously. Specifications apply to single-pole fuses. The number of permissible drivers must be reduced by 20% for multi-pole fuses. The considered circuit impedance equals 400 mΩ (approx. 20 m [2.5 mm²] of conductor from the power supply to the distributor and a further 15 m to the luminaire).

The values contained in this data sheet can change due to technical innovations. Any such changes will be made without separate notification.

Assembly and Safety Information

Selection of automatic cut-outs for VS LED drivers

Type	Ref. No.	Automatic cut-out type and possible no. of VS drivers pcs.		
Automatic cut-out type B		B 10 A	B 13 A	B 16 A
ECXe 350.278	186719, 186720	32	42	50
ECXe 500.279	186721, 186722	32	42	50
ECXe 700.280	186723, 186724	32	42	50
ECXe 900.281	186725, 186726	32	42	50
ECXe 1050.282	186727, 186728	32	42	50
Automatic cut-out type C		C 10 A	C 13 A	C 16 A
ECXe 350.278	186719, 186720	52	42	85
ECXe 500.279	186721, 186722	52	42	85
ECXe 700.280	186723, 186724	52	42	85
ECXe 900.281	186725, 186726	52	42	85
ECXe 1050.282	186727, 186728	52	42	85

- To limit capacitive inrush currents the current carrying capacity of each circuit breaker (fuse) can be increased by a factor of 2.5 with the help of our ESB (Ref. No.: 149820, 149821, 149822) inrush current limiters.